

XPR-10S

Two-Post Lifts

SKU# 5175395

10,000-lb. Capacity, Clearfloor, Adjustable Width, Screw Pads

Questions? Contact BendPak's Sales Team

sales@bendpak.com | 1-800-253-2363

Monday - Friday, 7AM to 4:30PM PST

XPR-10S Two-Post Lift Offers More Power, More Options

The XPR-10S [two-post lift](#) offers exceptional direct-drive lifting performance. This industrial-strength car lift guarantees cutting-edge technology, top of the line materials, a design that's ahead of its time and a 10,000-lb. lifting capacity. All height/width variations fit in shops with ceilings higher than 12', and none of them will crowd your floor while you work beneath a vehicle. Every XPR-10S two-post lift features our telescoping screw pad assembly kit.

Options

SKU#	Model	Description
5175396	XPR-10S-LP	Low-Profile Arms
5175399	XPR-10S-168	168" Overall Height
5175400	XPR-10S-168-LP	168" OAH / Low-Profile

Features

- Expandable top beam for wide or narrow drive-thru
- Double-telescoping screw pads offer increased versatility
- Padded overhead safety shutoff bar
- Telescoping arm design for more versatile arm positioning
- Single-point safety release
- Drop-end arms provide a lower pad height
- Dual hydraulic direct-drive cylinders
- Oversized 53" tall carriage for superior strength
- Electric / hydraulic power system
- Large, 17" x 19" A36 steel base plate
- Self-lubricating dura-glide UHMW polyethylene bearings
- Safety locks in each column spaced every 3"
- Automatic arm restraints
- Heavy-duty 1/2" aircraft-quality equalizer cables
- Oversized cable sheave diameter reduces cable fatigue
- 4-piece 63 mm stackable adapter set comes standard
- Triple-telescoping arm design
- Versatile drop-in contact pads with stackable adapters
- ETL Approved



Why choose a symmetric car lift

Our XPR-10S symmetric two-post lift features an adjustable top beam to accommodate wide or narrow installation setups. This unique configurable design allows you to choose the best setting for your specific space or vehicle lifting requirements. The highly sophisticated yet simple and dependable XPR-Series design requires very little service or maintenance for an overall lower cost of ownership.

Direct-Drive two-post car lift technology

The XPR-10 two-post lift features low-pressure HVLP direct-drive cylinders, eliminating the need for lifting chains or screw mechanisms most commonly found on other lift designs. Dual HVLP low-pressure cylinders minimize leakage and offer better reliability, smoother operation and fewer maintenance costs throughout the life of your lift. High volume and low pressure equates to less workload placed on the entire hydraulic system. Direct-Drive technology is preferred on commercial-grade two-post car lifts, as it has fewer moving parts than a chain-over-roller cylinder configuration. Pressurized hydraulic fluid flows from the power unit to the hollow cylinder rods, entering the cylinder body and filling its internal cavity. The pressure of the hydraulic fluid extends the piston rod downward, raising the cylinder body and lift carriages.

Specifications

Model	XPR-10S	XPR-10XLS
Style	Symmetric	Symmetric / High Rise
SKU#	5175390	5175129
Lifting Capacity	10,000 lbs. (4,536 kg)	10,000 lbs. (4,536 kg)
A - Rise	69" (1,753 mm)	75" (1,905 mm)
B - Rise + Pad Only	73" (1,854 mm)	79.75" (2,026 mm)
C - Max. Lifting Height	79" (2,007 mm)	82.25" (2,089 mm)
D - Min. Height + Pad	4" (102 mm)	4.75" (121 mm)
E - Height Overall (*)	145" (3,683 mm)	157" (3,988 mm)
F - Width Overall	132" (3,353 mm) or 145" (3,683 mm)	132" (3,353 mm) or 145" (3,683 mm)
G - Outside Columns	126.75" (3,220 mm) or 139.75" (3,555 mm)	126.75" (3,219 mm) or 139.75" (3,550 mm)
H - Inside Columns	105.5" (2,680 mm) or 118.5" (3,010 mm)	105.5" (2,680 mm) or 118.5" (3,010 mm)
I - Drive-Thru Clearance	93" (2,362 mm) or 106" (2,692 mm)	93" (2,362 mm) or 106" (2,692 mm)
J - Floor to Top Switch (*)	141" (3,581 mm)	147" (3,734 mm)
K - Front Arm Reach (MIN)	27.5" (698 mm)	25.5" (648 mm)
K - Front Arm Reach (MAX)	51.5" (1,308 mm)	49.5" (1,257 mm)
L - Rear Arm Reach (MIN)	34" (863 mm)	32.25" (819 mm)
L - Rear Arm Reach (MAX)	54.5" (1,384 mm)	52.5" (1,334 mm)
Screw Pad Adjustment	2" (51 mm)	2" (51 mm)
Max. Load per Arm	2,500 lbs. (1,134 kg)	2,500 lbs. (1,134 kg)
Time to Full Rise	45 seconds	45 seconds
Noise	45 dB	45 dB
Motor	220 VAC / 60 Hz / 1 Ph	220 VAC / 60 Hz / 1 Ph

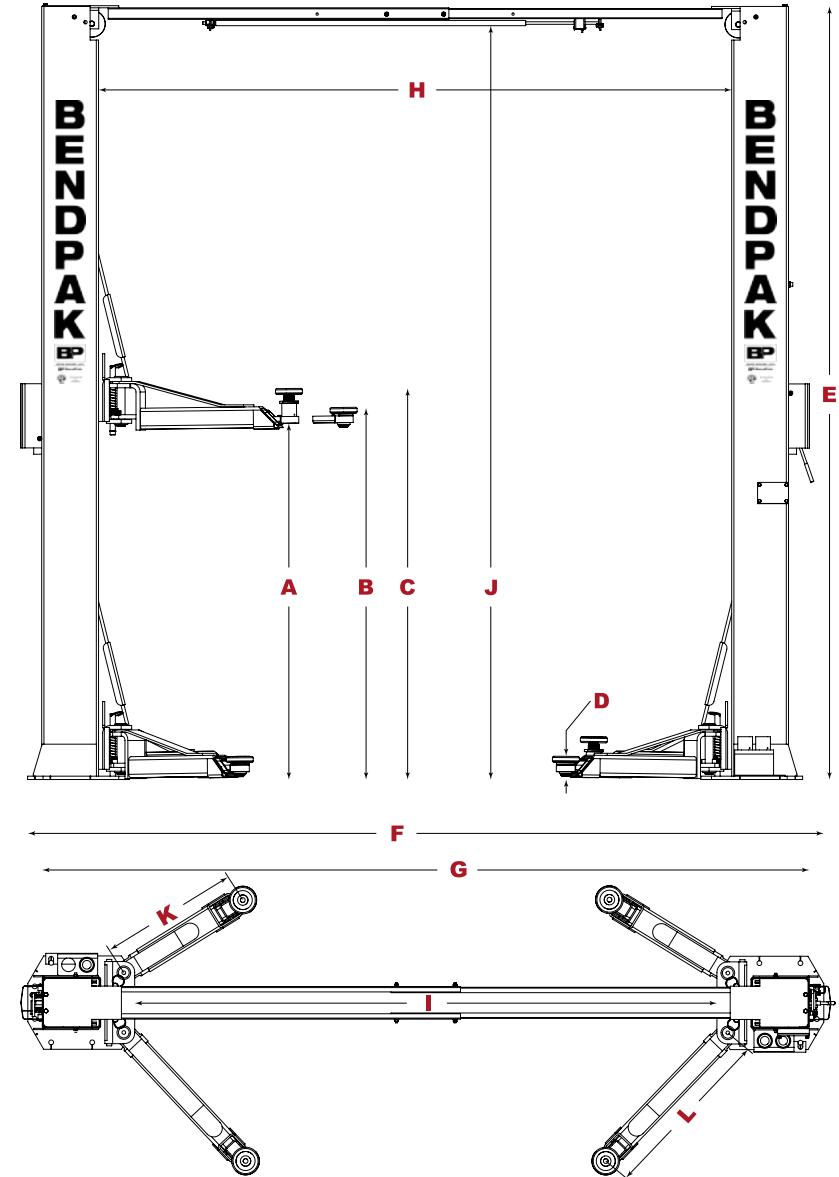

*Optional bolt-on top extension for columns raises the overall height and overhead safety bar an additional 24". Must be ordered from BendPak at time of order.

Not all BendPak lift models meet the standards as prescribed by ANSI/ALI ALCTV-2017 or ANSI/UL 201. Consult www.autolift.org for a complete list or contact BendPak via contact@bendpak.com.